

m o o o i<sup>®</sup>



---

## Container Table 7130

by Marcel Wanders

The Container Table concept is a fully versatile system that has endless composition possibilities to fit in any space. With combinations to suit your home, office or public space the Container Table can certainly exceed any requirements.

---

<b>Designer</b>	Marcel Wanders
<b>Year of design</b>	2001
<b>Material</b>	Container Foot: PE, Top: HPL, Laquered Wood, Stained Wood, Linoleum

---

---

## Foot colours

---

## Foot Colours

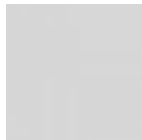

Light Grey, Ral  
7035



Terracotta, Ral  
2013



Concrete, Ral  
7013 + 7006

White, Ral 9016



Black, Ral 9017

---

## The container Tops are available in the following materials and colours:



HPL, A flat panel based on thermosetting resins, homogeneously reinforced with woodfibres and manufactured under high pressure and at high temperatures:

Thickness top 1.2cm | 0.5"

Also for outdoor use

Available in white, black and light grey. The trim is always black.



Oak veneer, stained and lacquered:

Thickness top 4cm | 1.6"

For indoor use only

Available in the 6 Moooi stain colours, and 25 Moooi Ral Colours



Linoak:

Thickness top, 4cm | 1.6"

For indoor use only

The solid oak edge is available in the 6 Moooi stain colours, the linoleum centre is available in Mauve, Pewter and Nero.

---

## The container feet are available in the following shapes and colours



**Classic** - In colours: White, Black, Light Grey, Terracotta, Concrete

# m o o o i<sup>®</sup>



**New Antiques** - In colours: White, Black, Light Grey, Terracotta, Concrete





**Bodhi Cover** - In colours: Black, Cinnamon, Grey, Natural Oil, Wenge, White Wash

## Container General

The container table top range all attached to the container foot in the same way. The container concept is that sand, pebbles or water can be added to the foot to give it strength and stability. Water must always be treated with an anti-algae additive to prevent the water from becoming stale. There are Hex-bolts on the underside of each table which align with equally spaced holes in the container foot.

## Container Table 7130 - 7132 options

						FOOT	dining table
						 <i>Classic</i>	<b>7130</b> 71cm   28" x 30cm   11.8 "
						 <i>Bodhi</i>	<b>7130</b> 71cm   28" x 30cm   11.8 "
						 <i>New Antiques</i>	<b>7132</b> 71cm   28" x 32m   12.6 "
CONTAINER FAMILY		Top					
Shape	L	W	HPL	Wood	Linoak		
							<i>Number of feet required</i>
Rectangle	80cm   31.5"	180cm   70.9"	x	x	x	2	
Round	∅	70cm   27.6"	x	x	x	1	
Round	∅	90cm   35.4"	x	x	x	1	
Square	70cm   27.6"	70cm   27.6"	x	x	x	1	
Square	80cm   31.5"	80cm   31.5"	x	x	x	1	
Square	90cm   35.4"	90cm   35.4"	x	x	x	1	

---

## HPL colours

HPL tops are available in the following colours



Black



Grey

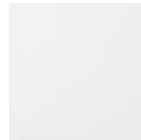

White

---

## Container table top - Linoak

The center of the Linoak top is made of linoleum, and available in the following colours. The solid oak edge is available in one of the 6 moooi stain colours.

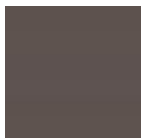

mauve



nero



pewter

---

## Container Table top & Bodhi covers - Wood Stained Colours

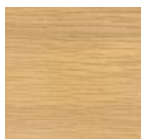

White Wash

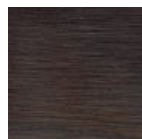

Wenge

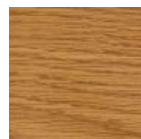

Natural Oil

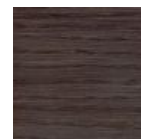

Grey

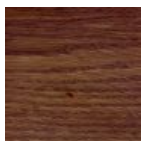

Cinnamon



Black Stained

## Container Table Top - Ral Colours

Available RAL Colours:

1004 1013 1023 1027 2000 2002 2004 3012 3015 5003 5008 5024 6010 6021 7001 7011 7035 7044 8001 8014 8016 9005 9010 9016 3003

	RAL 1004		RAL 1013		RAL 1023		RAL 1027
	RAL 2000		RAL 2002		RAL 2004		RAL 3003
	RAL 3012		RAL 3015		RAL 5003		RAL 5008
	RAL 5024		RAL 6010		RAL 6021		RAL 7001
	RAL 7011		RAL 7035		RAL 7044		RAL 8001
	RAL 8014		RAL 8016		RAL 9005		RAL 9010
	RAL 9016						

## cleaning instructions

Moooki recommends using a good furniture polish and a soft cloth. Apply generously in layers to the surface and use the cloth to shine. Do not use abrasive fabrics, gently remove tough stains with warm water and a trusted multi-surface cleaner.

---

## packaging

### **Bodhi Cover 7030**

H 68 cm | 26,8"

W 18 cm | 7,1"

D 18 cm | 7,1"

Colli 1/1

Product weight:

5,5 KG | 12,1 lb

With packaging:

6,5 KG | 14,3 lb

### **Container Table Foot 7030**

H 73 cm | 28,7"

W 31 cm | 12,2"

D 31 cm | 12,2"

Colli 1/1

Product weight:

4,5 KG | 9,9 lb

With packaging:

5,5 KG | 12,1 lb

### **Container, New Antiques 7132**

H 74 cm | 29,1"

W 35 cm | 13,8"

D 35 cm | 13,8"

Colli 1/1

Product weight:

5 KG | 11 lb

With packaging:

6 KG | 13,2 lb

---

## Packaging 70x 70 and round 70 tops

HPL

H 3 cm | 1.2"

W 71 cm | 27.9"

D 71 cm | 27.9"

70 x 70

Colli 1

Product weight:

8,2 KG | 17,6 lb

With packaging:

10 KG | 22 lb

70Ø

Colli 1

Product weight:

6,4 KG | 14,1 lb

With packaging:

8,4 KG | 18,5 lb

LPL

H 4 cm | 1.6"

W 71 cm | 27.9"

D 71 cm | 27.9"

70 x 70

Colli 1

Product weight:

9,3 KG | 20,5 lb

With packaging:

11,3 KG | 25 lb

70Ø

Colli 1

Product weight:

7,3 KG | 16 lb

With packaging:

9,3 KG | 20,5 lb

Wood & Linoak

H 8 cm | 3.1"

W 76 cm | 29.9"

D 76 cm | 29.9"

70 x 70

Colli 1

Product weight:

15,6 KG | 34,4 lb

With packaging:

17,6 KG | 38,8 lb

70Ø

Colli 1

Product weight:

12,3 KG | 27,1 lb

With packaging:

14,3 KG | 31,5 lb

---

## Packaging 80x80 tops



HPL  
H 3 cm | 1.2"  
W 81 cm | 31.8"  
D 81 cm | 31.8"  
Colli 1  
Product weight:  
10,7 KG | 23,6 lb  
With packaging:  
13,2 KG | 29,1 lb

Wood & Linoak  
H 8 cm | 3.1"  
W 86 cm | 33.8"  
D 86 cm | 33.8"  
Colli 1  
Product weight:  
20,5 KG | 45,2 lb  
With packaging:  
23 KG | 50,7 lb

---

## Packaging 90x90 and Round 90 tops

HPL  
H 3 cm | 1.2"  
W 91 cm | 35.8"  
D 91 cm | 35.8"

Wood & Linoak  
H 8 cm | 3.1"  
W 96 cm | 37.8"  
D 96 cm | 37.8"

90 x 90  
Colli 1  
Product weight:  
13,5 KG | 29,7 lb  
With packaging:  
16 KG | 35,3 lb

90 x 90  
Colli 1  
Product weight:  
26 KG | 57,3 lb  
With packaging:  
28,5 KG | 62,8 lb

90Ø  
Colli 1  
Product weight:  
10,6 KG | 23,4 lb  
With packaging:  
13,1 KG | 28,8 lb

90Ø  
Colli 1  
Product weight:  
20,4 KG | 45 lb  
With packaging:  
22,9 KG | 50,5 lb

---

## Packaging 180x80 tops

HPL  
H 3 cm | 1.2"  
W 181 cm | 71.3"  
D 81 cm | 31.9"  
Colli 1  
Product weight:  
24 KG | 53 lb  
With packaging:  
29 KG | 64 lb

Wood & Linoak  
H 8 cm | 3.1"  
W 186 cm | 73.2"  
D 86 cm | 33.9"  
Colli 1  
Product weight:  
46,1 KG | 101,6 lb  
With packaging:  
51,1 KG | 112,7 lb



## Dimensions

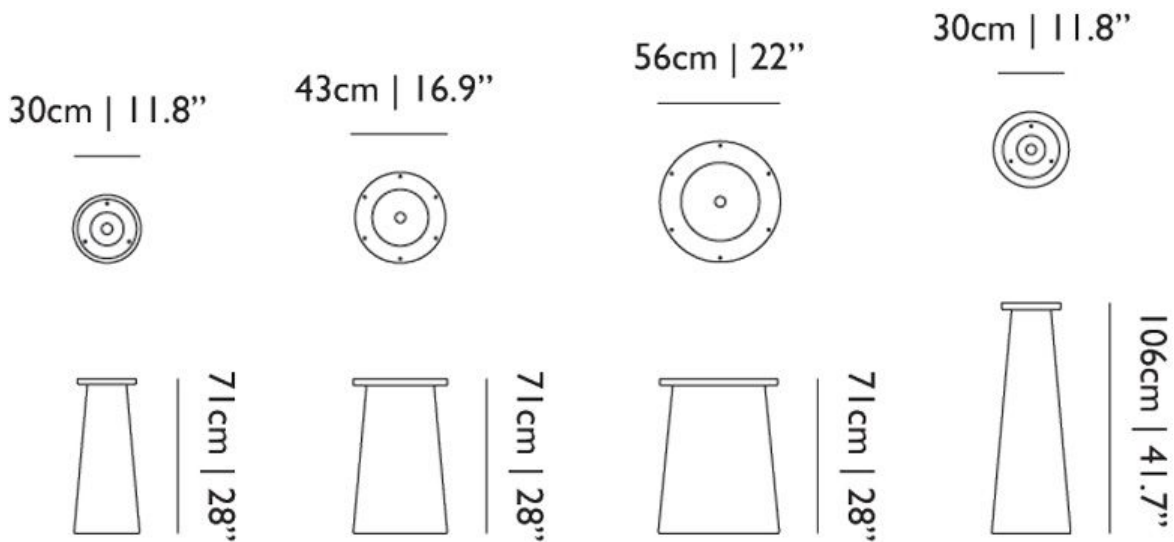

## Dimensions New Antiques

